

Das INO^{Top}® Spannsystem kann auf nahezu jedem vorhandenen Spann-
futter ab einer Durchmessergröße von
200 mm, unabhängig vom Backen-
anschluss verwendet werden. Verfor-
mungen durch den Spannprozess sind
damit kein Thema mehr.

The INO^{Top}® clamping system can
be used on almost any existing chuck
from a diameter of 200 mm, no
matter which jaw connection is
used. Deformations caused by the
clamping process are therefore no
longer an issue.

INOTop®

Spannen ohne Druck
Clamping without pressure

OPTIMALE RUNDHEIT DURCH GEGENLAGER

Mit **INOTop®** erreichen Sie höchste Rundheiten durch das Prinzip des „festen Gegenlagers“. Speziell dünnwandige Bauteile können mit **INOTop®** polygonfrei gespannt werden.

- Zentrieren des Bauteils ohne Druck von außen
- Für polygonfreies Spannen
- Perfekte Rundheitsergebnisse
- Definierte Kräfteinleitung durch die bewegliche Spannbacke
- Kostengünstig in der Anschaffung
- Keine teuren Sonderspannlösungen notwendig

OPTIMAL ROUNDNESS DUE TO COUNTER BEARINGS

INOTop® produces best roundness results thanks to the fixed counter bearing principle. By using **INOTop®**, thin-walled parts in particular can be clamped without polygon formation.

- Part is centred without pressure from outside for clamping
- Without polygon formation
- Perfect roundness results
- Defined clamping force by the moveable jaw
- Low-costs
- No expensive special clamping solutions needed



Verformungsarm Spannen

Low deformation clamping

SPANNEN OHNE DRUCK

Die innovative **INOTop**[®]-Hybridspannbacke von HWR wurde speziell für verformungsempfindliche Bauteile in der Drehbearbeitung konzipiert. Verformungsempfindliche Bauteile werden im herkömmlichen Spannfutter mit **INOTop**[®] ohne Druck von außen über die Futterfunktion nur zentriert und dann von innen gespannt. Damit verhindert **INOTop**[®] unerwünschte Polygonbildungen im Spannprozess. Drehergebnisse, die zuvor nur mit kostenintensiven Sonderspannlösungen zu realisieren waren, können nun ganz einfach mit der **INOTop**[®]-Hybridspannbacke von HWR günstig erreicht werden. Mit **INOTop**[®] erreichen Sie höchste Rundheiten durch das Prinzip des festen Gegenlagers.



CLAMPING WITHOUT PRESSURE

The innovative **INOTop**[®] hybrid clamping jaw by HWR was designed specifically for turning deformation-sensitive parts. In conventional chucks with **INOTop**[®], components that are sensitive to deformation are simply centred without external pressure via the chuck function and then clamped from the inside. **INOTop**[®] thus prevents unwanted polygon formation. Turning results that were previously only possible with costly special clamping solutions can now be achieved at low cost quite easily. With the innovative **INOTop**[®] hybrid clamping jaws by HWR, **INOTop**[®] produces best roundness results thanks to the fixed counter bearing principle.

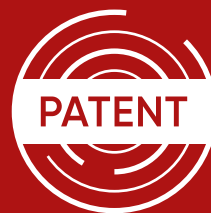

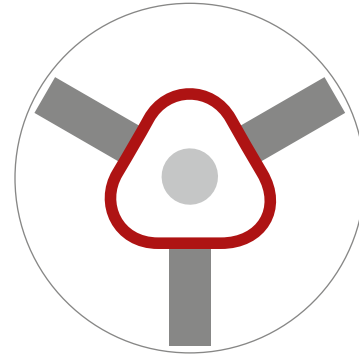

Herkömmliche 3-Punkt-Spannung
Conventional 3-point clamping

DAS FUNKTIONSPRINZIP

Beim herkömmlichen Spannen wird der Spanndruck über die Spannpunkte in das Werkstück eingeleitet. Bei dünnwandigen Werkstücken nimmt dieser Spanndruck erheblichen Einfluss auf die Geometrie des Werkstücks. Die Folge ist eine Verformung durch den Spannprozess, welche sich negativ auf die Rundheitsergebnisse auswirkt.

Bei der Verwendung von INO^{Top}® wird die Funktion des Spannfutters nur zum Zentrieren des Werkstücks und nicht für den Spannprozess selbst verwendet. Das bedeutet, dass der Spanndruck so weit reduziert werden kann, dass nach dem Zentrieren des Werkstücks kein weiterer Spanndruck ins Werkstück eingeleitet wird. Im Anschluss an den Zentriervorgang wird nun über die manuelle Betätigung der Spindel in der INO^{Top}®-Backe die bewegliche Greiferbacke von innen gegen die Zentrierung, das feste Gegenlager, gezogen. Die Spannung findet ohne Einfluss auf die Werkstückgeometrie statt.

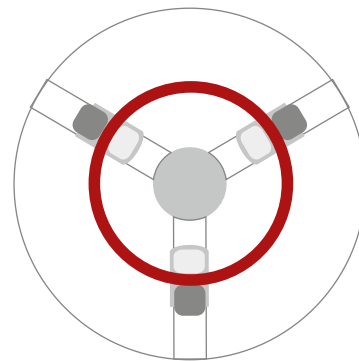

Das INO^{Top}®-Gegenlagerprinzip
The INO^{Top}® counter bearing principle

HOW IT WORKS

In conventional clamping, the clamping pressure is introduced into the workpiece via the clamping points. With thin-walled workpieces, this clamping pressure has a considerable influence on the geometry of the workpiece. The result is a deformation due to the clamping process, which has a negative effect on the roundness results.

When INO^{Top}® is used, the function of the chuck is only used for centering the workpiece and not for the clamping process itself. This means that the clamping pressure can be reduced to such an extent that no further clamping pressure is applied to the workpiece after the workpiece has been centered. Following the centering process, the moving gripper jaw is now pulled from the inside against the centering, the fixed counter support, by manually actuating the spindle in the INO^{Top}® jaw. The clamping has no influence on the workpiece geometry.

INOTop®

Futterspezifische Daten Chuck specific data

Technische Daten siehe Seite 124-125

Technical data see page 124-125

Futterhersteller chuck manufacturer	Futtertyp chuck type	Futter- größe chuck size	Backenanschluss des Futters jaw-connection of the chuck		Typbe- zeichnung type de- signation	Ident-Nr. ident-no.	Spannbereich [aussen] clamping range [external] min.-max./mm	Bauteilwand- stärke wall thickness of workpiece min.-max./mm	Schwing- kreis swing Ø mm	* Benötigter Nutenstein * needed t-nut
			ø mm	S mm / V						
Auto Strong	N-208	210	V = 1,5mm x 60°	N = 14	TM030	813030	150 - 210	3 - 25	290	GP09
	V-208		V = 1,5mm x 60°	N = 14	TM030	813030	150 - 210	3 - 25	290	GP08
	N-210	254	V = 1,5mm x 60°	N = 16	TM040	813040	165 - 254	3 - 25	335	TT70
	V-210		V = 1,5mm x 60°	N = 16	TM040	813040	160 - 254	3 - 25	335	TT22
	N-212	304	V = 1,5mm x 60°	N = 21	TM052	813052	195 - 304	3 - 25	385	TT40
	V-212		V = 1,5mm x 60°	N = 18	TM050	813050	185 - 304	3 - 25	385	GN78
	N-215	381	V = 1,5mm x 60°	N = 22	TM060	813060	275 - 381	6 - 50	490	GP15
	V-215		V = 1,5mm x 60°	N = 25,5	TM060	813060	275 - 381	6 - 50	490	X5507
	N-218	450	V = 3,0mm x 60°	N = 25,5	TM060	813060	275 - 450	6 - 50	560	GP15
	V-218		V = 3,0mm x 60°	N = 25,5	TM060	813060	335 - 450	6 - 50	560	X5507
	N-220	510	V = 3,0mm x 60°	N = 25,5	TM080	813080	345 - 510	6 - 50	620	GP15
	N-221	530	V = 3,0mm x 60°	N = 25,5	TM080	813080	295 - 530	6 - 50	640	X5507
	V-221		V = 3,0mm x 60°	N = 25,5	TM080	813080	295 - 530	6 - 50	640	
	N-224	610	V = 3,0mm x 60°	N = 25,5	TM080	813080	405 - 610	6 - 50	720	
	V-224		V = 3,0mm x 60°	N = 25,5	TM080	813080	375 - 610	6 - 50	720	
V-232	810	V = 3,0mm x 60°	N = 25,5	TM080	813080	335 - 810	6 - 50	920		
Bison	3200 / 3500 - 200	200	S = 7,94	N = 12,69	TZ031	814031	150 - 200	3 - 25	280	
	3200 / 3500 - 250	250	S = 12,7	N = 19,04	TZ040	814040	150 - 250	3 - 25	330	
	3200 / 3500 - 315	315	S = 12,7	N = 19,04	TZ043	814043	185 - 315	3 - 25	395	
	3200 / 3500 - 400	400	S = 12,7	N = 19,04	TZ060	814060	250 - 400	6 - 50	510	
	3200 / 3500 - 500	500	S = 12,7	N = 19,04	TZ063	814063	250 - 500	6 - 50	610	
Forkardt	F+ 200	200	S = 10	N = 20	TK030	811030	150 - 206	3 - 25	290	
	FNC 200		S = 10	N = 20	TK030	811030	150 - 206	3 - 25	290	
	KTG / KTN 200		V = 1/16" x 90°	N = 17	TD040	812040	150 - 200	3 - 25	280	GG20
	NH / NHF 200		V = 1/16" x 90°	N = 17	TD040	812040	150 - 200	3 - 25	280	GG20
	QLC / QLK 200		V = 1,5mm x 60°	N = 14	TM030	813030	155 - 210	3 - 25	290	*
	QLC / QLK 200		V = 1/16" x 90°	N = 17	TD040	812040	150 - 210	3 - 25	290	GG20
	QLC-KS / QLK-KS 200		V = 1/16" x 90°	N = 17	TD040	812040	155 - 200	3 - 25	280	GG20

* Sondernutenstein
* special t-nut

Futterhersteller chuck manufacturer	Futtertyp chuck type	Futter- größe chuck size	Backenanschluss des Futters jaw-connection of the chuck		Typbe- zeichnung type de- signation	Ident-Nr. ident-no.	Spannbereich [ausen] clamping range [external] min.-max./mm	Bauteilwand- stärke wall thickness of workpiece min.-max./mm	Schwing- kreis swing Ø mm	* Benötigter Nutenstein * needed t-nut
			S mm / V	N mm						
Forkardt	F+ 250	250	S = 12	N = 20	TK040	811040	150 - 255	3 - 25	335	
	FNC 250		S = 12	N = 20	TK040	811040	150 - 250	3 - 25	330	
	KTG / KTN 250		V = 1/16" x 90°	N = 21	TD046	812046	150 - 250	3 - 25	330	TT35
	KTNC 250		S = 12	N = 20	TK040	811040	150 - 225	3 - 25	305	
	NH / NHF 250		V = 1/16" x 90°	N = 21	TD046	812046	155 - 250	3 - 25	330	TT35
	QLC / QLK 250		V = 1,5mm x 60°	N = 16	TM040	813040	165 - 257	3 - 25	340	TT70
	QLC / QLK 250		V = 1/16" x 90°	N = 21	TD046	812046	160 - 257	3 - 25	340	TT35
	QLC-KS / QLK-KS 250		V = 1,5mm x 60°	N = 16	TM040	813040	200 - 257	3 - 25	340	GN16
	QLC-KS / QLK-KS 250		V = 1/16" x 90°	N = 17	TD040	812040	185 - 257	3 - 25	340	GG20
	F+ 315		315	S = 12	N = 26	TK050	811050	150 - 318	3 - 25	400
	FNC 315	S = 12		N = 20	TK040	811040	150 - 315	3 - 25	395	
	KTG / KTN 315	V = 1/16" x 90°		N = 21	TD046	812046	150 - 315	3 - 25	395	TT35
	KTNC 315	S = 12		N = 20	TK040	811040	150 - 285	3 - 25	365	
	NH / NHF 315	V = 1/16" x 90°		N = 21	TD046	812046	165 - 315	3 - 25	395	TT35
	QLC / QLK 315	V = 1,5mm x 60°		N = 21	TM052	813052	195 - 320	3 - 25	400	TT35
	QLC / QLK 315	V = 1/16" x 90°		N = 21	TD046	812046	175 - 320	3 - 25	400	TT35
	QLC-KS / QLK-KS 315	V = 1,5mm x 60°		N = 21	TM052	813052	245 - 320	3 - 25	400	TT35
	QLC-KS / QLK-KS 315	V = 1/16" x 90°		N = 21	TD046	812046	225 - 320	3 - 25	400	TT35
	F+ 400	400		S = 18	N = 30	TK080	811080	250 - 400	6 - 50	510
	FNC 400		S = 12	N = 26	TK060	811060	250 - 388	6 - 50	495	
	KTG / KTN 400		V = 3/32" x 90°	N = 25,5	TD066	812066	250 - 400	6 - 50	510	GN40
	KTNC 400		S = 12	N = 26	TK060	811060	250 - 374	6 - 50	480	
	KTNC 400		S = 12	N = 26	TK060	811060	250 - 374	6 - 50	480	
	NHF 400		V = 1/16" x 90°	N = 21	TD060	812060	260 - 400	6 - 50	510	*
	NHF 400		V = 3/32" x 90°	N = 25,5	TD066	812066	260 - 400	6 - 50	510	GN40
	QLC / QLK 400		V = 1,5mm x 60°	N = 21	TM062	813062	280 - 400	6 - 50	510	TT35
	QLC / QLK 400		V = 1/16" x 90°	N = 21	TD060	812060	270 - 400	6 - 50	510	*
	QLC / QLK 400		V = 3/32" x 90°	N = 25,5	TD066	812066	270 - 400	6 - 50	510	GN40
	QLC-KS / QLK-KS 400	V = 1,5mm x 60°	N = 21	TM062	813062	310 - 400	6 - 50	510	TT35	
	QLC-KS / QLK-KS 400	V = 1/16" x 90°	N = 21	TD060	812060	295 - 400	6 - 50	510	GN25	
F+ 500	500	S = 18	N = 30	TK080	811080	250 - 500	6 - 50	610		
FNC 500		S = 18	N = 30	TK080	811080	250 - 500	6 - 50	610		
KTNC 500		S = 18	N = 30	TK080	811080	250 - 459	6 - 50	565		

INOTop®

Futterspezifische Daten Chuck specific data

Technische Daten siehe Seite 124-125

Technical data see page 124-125

Futterhersteller chuck manufacturer	Futtertyp chuck type	Futter- größe chuck size	Backenanschluss des Futters jaw-connection of the chuck		Type- zeichnung type de- signation	Ident-Nr. ident-no.	Spannbereich [ausßen] clamping range [external]	Bauteilwand- stärke wall thickness of workpiece	Schwing- kreis swing	* Benötigter Nutenstein * needed t-nut
			ø mm	S mm / V						
HWR	VD026	260	V = 1,5mm x 60°	N = 16	TM040-4	813141	170 - 255	3 - 25	371	TT70
	VK026		V = 1,5mm x 60°	N = 16	TM040-4	813141	170 - 255	3 - 25	371	TT70
	VK-S 026		V = 1,5mm x 60°	N = 16	TM040-4	813141	170 - 255	3 - 25	371	TT70
	VM026		V = 1,5mm x 60°	N = 16	TM040-4	813141	170 - 255	3 - 25	371	TT70
	VT026		V = 1,5mm x 60°	N = 16	TM040-4	813141	190 - 264	3 - 25	371	TT70
	VT-S 026		V = 1,5mm x 60°	N = 16	TM040-4	813141	190 - 264	3 - 25	371	TT70
	VD031	315	V = 1,5mm x 60°	N = 16	TM040-4	813141	170 - 315	3 - 25	425	TT70
	VK031		V = 1,5mm x 60°	N = 16	TM040-4	813141	170 - 315	3 - 25	425	TT70
	VM031		V = 1,5mm x 60°	N = 16	TM040-4	813141	170 - 315	3 - 25	425	TT70
	VT031		V = 1,5mm x 60°	N = 16	TM040-4	813141	215 - 315	3 - 25	425	TT70
	VT-S 031		V = 1,5mm x 60°	N = 16	TM040-4	813141	215 - 315	3 - 25	425	TT70
	VD040	400	V = 1,5mm x 60°	N = 21	TM062-4	813162	280 - 400	6 - 50	566	TT65
	VK040		V = 1,5mm x 60°	N = 21	TM062-4	813162	280 - 400	6 - 50	566	TT65
	VK-S 040		V = 1,5mm x 60°	N = 21	TM062-4	813162	280 - 400	6 - 50	566	TT65
	VM040		V = 1,5mm x 60°	N = 21	TM062-4	813162	280 - 400	6 - 50	566	TT65
	VT040		V = 1,5mm x 60°	N = 21	TM062-4	813162	280 - 400	6 - 50	566	TT65
	VT-S 040		V = 1,5mm x 60°	N = 21	TM062-4	813162	280 - 400	6 - 50	566	TT65
	VL042	420	V = 1,5mm x 60°	N = 16	TM040-4	813141	170 - 420	3 - 25	525	TT70
	VD050	500	V = 3,0mm x 60°	N = 25	TM080-4	813180	280 - 500	6 - 50	660	TT55
	VK050		V = 3,0mm x 60°	N = 25	TM080-4	813180	295 - 500	6 - 50	660	TT55
	VK-S 050		V = 3,0mm x 60°	N = 25	TM080-4	813180	330 - 500	6 - 50	660	TT55
	VT050		V = 3,0mm x 60°	N = 25	TM080-4	813180	335 - 500	6 - 50	660	TT55
	VT-S 050		V = 3,0mm x 60°	N = 25	TM080-4	813180	335 - 500	6 - 50	660	TT55
	VL060	600	V = Modul 2	N = 16	TR060-4	816160	280 - 600	6 - 50	740	GP11
	VD063	630	V = 3,0mm x 60°	N = 25	TM080-4	813180	280 - 630	6 - 50	792	TT55
	VK063		V = 3,0mm x 60°	N = 25	TM080-4	813180	320 - 630	6 - 50	792	TT55
	VK-S 063		V = 3,0mm x 60°	N = 25	TM080-4	813180	320 - 630	6 - 50	792	TT55
	VT-S 063		V = 3,0mm x 60°	N = 25	TM080-4	813180	320 - 630	6 - 50	792	TT55
	VL070	700	V = Modul 2	N = 16	TR060-4	816160	280 - 700	6 - 50	840	GP11
	VD080	800	V = 3,0mm x 60°	N = 25	TM080-4	813180	290 - 800	6 - 50	961	TT55
VK080	V = 3,0mm x 60°		N = 25	TM080-4	813180	295 - 800	6 - 50	961	TT55	

Futterhersteller chuck manufacturer	Futtertyp chuck type	Futter- größe chuck size	Backenanschluss des Futters jaw-connection of the chuck		Type- zeichnung type de- signation	Ident-Nr. ident-no.	Spannbereich [aussein] clamping range [external] min.-max./mm	Bauteilwand- stärke wall thickness of workpiece min.-max./mm	Schwing- kreis swing Ø mm	* Benötigter Nutenstein * needed t-nut
			S mm / V	N mm						
HWR	VK-S 080	800	V = 3,0mm x 60°	N = 25	TM080-4	813180	295 - 800	6 - 50	961	TT55
	VT-S 080		V = 3,0mm x 60°	N = 25	TM080-4	813180	295 - 800	6 - 50	961	TT55
	VD100	990	V = 3,0mm x 60°	N = 25	TM080-4	813180	290 - 990	6 - 50	1161	TT55
	VK-S 100		V = 3,0mm x 60°	N = 25	TM080-4	813180	335 - 990	6 - 50	1161	TT55
	VL100		V= Modul 2	N = 21	TR080-4	816180	280 - 990	6 - 50	1135	GP13
	VL120	1150	V= Modul 2	N = 21	TR080-4	816180	280 - 1150	6 - 50	1295	GP13
	VL140	1400	V= Modul 2	N = 21	TR080-4	816180	280 - 1400	6 - 50	1545	GP13
	VL160	1600	V= Modul 2	N = 21	TR080-4	816180	280 - 1600	6 - 50	1745	GP13
	VL180	1800	V= Modul 2	N = 21	TR080-4	816180	280 - 1800	6 - 50	1945	GP13
VL200	2000	V= Modul 2	N = 21	TR080-4	816180	280 - 2000	6 - 50	2145	GP13	
HWR INOZet®	WT025	250	V = 2,0mm x 60°	N = 12	TW020	815020	205 - 250	3 - 25	328	GP07
	WT031	315	V = 2,0mm x 60°	N = 12	TW020	815020	205 - 315	3 - 25	393	GP07
	WT031-4		V = 2,0mm x 60°	N = 12	TW020-8	815121	240 - 315	3 - 25	393	GP07
	WT038	380	V = 3,5mm x 60°	N = 16	TW030	815030	325 - 380	6 - 50	484	GP11
	WT040	400	V = 3,5mm x 60°	N = 16	TW030	815030	325 - 400	6 - 50	504	GP11
	WT045	450	V = 3,5mm x 60°	N = 16	TW030	815030	325 - 450	6 - 50	554	GP11
	WT050	500	V = 3,5mm x 60°	N = 21	TW040	815040	325 - 500	6 - 50	604	GP13
	WT050-4		V = 3,5mm x 60°	N = 16	TW030-8	815131	380 - 500	6 - 50	604	GP11
	WT053	530	V = 3,5mm x 60°	N = 21	TW040	815040	325 - 530	6 - 50	634	GP13
	WT063	630	V = 3,5mm x 60°	N = 21	TW040	815040	325 - 630	6 - 50	734	GP13
	WT063-4		V = 3,5mm x 60°	N = 16	TW030-8	815131	380 - 630	6 - 50	734	GP11
	WT070-4	700	V = 3,5mm x 60°	N = 16	TW030-8	815131	390 - 700	6 - 50	804	GP11
	WT080-4	800	V = 3,5mm x 60°	N = 21	TW040-8	815141	390 - 800	6 - 50	904	GP13
Kitagawa	B-208	210	V = 1,5mm x 60°	N = 14	TM030	813030	150 - 210	3 - 25	290	GP09
	BB-208		V = 1,5mm x 60°	N = 14	TM030	813030	150 - 210	3 - 25	290	GP09
	B-10	254	V = 1,5mm x 60°	N = 16	TM040	813040	165 - 254	3 - 25	335	TT22
	B-210		V = 1,5mm x 60°	N = 16	TM040	813040	170 - 254	3 - 25	335	TT70
	BB-210		V = 1,5mm x 60°	N = 16	TM040	813040	170 - 254	3 - 25	335	TT70
	N-10		V = 1,5mm x 60°	N = 16	TM040	813040	165 - 254	3 - 25	335	TT22
	B-12	304	V = 1,5mm x 60°	N = 18	TM050	813050	180 - 304	3 - 25	385	GN78
	B-212		V = 1,5mm x 60°	N = 21	TM052	813052	195 - 304	3 - 25	385	TT40
	N-12		V = 1,5mm x 60°	N = 18	TM050	813050	185 - 304	3 - 25	385	GN78
	BB-212	315	V = 1,5mm x 60°	N = 21	TM052	813052	195 - 315	3 - 25	395	TT36
	B-15	381	V = 1,5mm x 60°	N = 22	TM060	813060	275 - 381	6 - 50	490	GP15
	B-215		V = 1,5mm x 60°	N = 25,5	TM060	813060	255 - 381	6 - 50	490	X5507
N-15	V = 1,5mm x 60°		N = 25,5	TM060	813060	275 - 381	6 - 50	490	X5507	



INOTop®

Futterspezifische Daten Chuck specific data

Technische Daten siehe Seite 124-125

Technical data see page 124-125

* Sondernutenstein
* special t-nut

Futterhersteller chuck manufacturer	Futtertyp chuck type	Futter- größe chuck size ø mm	Backenanschluss des Futters jaw-connection of the chuck		Typbe- zeichnung type de- signation	Ident-Nr. ident-no.	Spannbereich [aussein] clamping range [external] min.-max./mm	Bauteilwand- stärke wall thickness of workpiece min.-max./mm	Schwing- kreis swing Ø mm	* Benötigter Nutenstein * needed t-nut
			S mm / V	N mm						
Kitagawa	B-18	450	V = 1,5mm x 60°	N = 22	TM060	813060	275 – 450	6 – 50	490	GP15
	BB-218		V = 1,5mm x 60°	N = 25,5	TM060	813060	275 – 450	6 – 50	560	X5507
	N-21	530	V = 3,0mm x 60°	N = 25	TM080	813080	330 – 450	6 – 50	560	
	B-21		V = 3,0mm x 60°	N = 25	TM080	813080	285 – 530	6 – 50	640	
	N-24	610	V = 3,0mm x 60°	N = 25	TM080	813080	315 – 530	6 – 50	720	
	B-24		V = 3,0mm x 60°	N = 25	TM080	813080	335 – 610	6 – 50	720	
	NV-24	700	V = 3,0mm x 60°	N = 25	TM080	813080	380 – 610	6 – 50	720	
	NV-28		V = 3,0mm x 60°	N = 25	TM080	813080	380 – 700	6 – 50	810	
Röhm	DURO 200	200	S = 10	N = 20	TK030	811030	150 – 206	3 – 25	290	
	DURO-A 200		S = 10	N = 20	TK030	811030	150 – 206	3 – 25	290	
	DURO-NC 200		S = 10	N = 20	TK030	811030	150 – 215	3 – 25	295	
	DURO-NCES 200		S = 10	N = 20	TK030	811030	150 – 215	3 – 25	295	
	DURO-T 200		S = 10	N = 20	TK030	811030	150 – 206	3 – 25	290	
	KFD 200		V = 1/16" x 90°	N = 17	TD040	812040	150 – 200	3 – 25	280	GE16
	KFD-HE 200		V = 1/16" x 90°	N = 17	TD040	812040	150 – 210	3 – 25	290	GE16
	KFD-HF 200		V = 1/16" x 90°	N = 21	TD046	812046	165 – 200	3 – 25	280	*
	KFD-HS 200		V = 1/16" x 90°	N = 17	TD040	812040	150 – 200	3 – 25	280	GE16
	LVE 200		V = 1/16" x 90°	N = 17	TD040	812040	150 – 200	3 – 25	280	GE16
	ZG / ZS 200	S = 7,96	N = 12,69	TZ030	814030	150 – 200	3 – 25	280		
	DURO-NCSE 210	210	S = 10	N = 20	TK030	811030	150 – 209	3 – 25	290	
	KFD-HE 210		V = 1,5mm x 60°	N = 14	TM030	813030	150 – 210	3 – 25	290	*
	DURO-NCSE 225	225	S = 10	N = 20	TK030	811030	150 – 225	3 – 25	305	
	DURO-NCSE 225		S = 10	N = 20	TK030	811030	150 – 225	3 – 25	305	
	DURO 250	250	S = 12	N = 20	TK040	811040	150 – 255	3 – 25	335	
	DURO-A 250		S = 12	N = 20	TK040	811040	150 – 249	3 – 25	330	
	DURO-NC 250		S = 12	N = 20	TK040	811040	150 – 260	3 – 25	340	
	DURO-NCES 250		S = 12	N = 20	TK040	811040	150 – 260	3 – 25	340	
	DURO-T 250		S = 12	N = 20	TK040	811040	150 – 256	3 – 25	340	

Futterhersteller chuck manufacturer	Futtertyp chuck type	Futter- größe chuck size	Backenanschluss des Futters jaw-connection of the chuck		Typbe- zeichnung type de- signation	Ident-Nr. ident-no.	Spannbereich [aussen] clamping range [external] min.-max./mm	Bauteilwand- stärke wall thickness of workpiece min.-max./mm	Schwing- kreis swing Ø mm	* Benötigter Nutenstein * needed t-nut
			S mm / V	N mm						
Röhmm	KFD 250	250	V = 1/16" x 90°	N = 21	TD046	812046	160 - 250	3 - 25	330	TT34
	KFD-HE 250		V = 1,5mm x 60°	N = 16	TM040	813040	170 - 254	3 - 25	335	TT70
	KFD-HE 250		V = 1/16" x 90°	N = 21	TD046	812046	165 - 254	3 - 25	335	TT34
	KFD-HS 250		V = 1/16" x 90°	N = 17	TD040	812040	150 - 250	3 - 25	330	GE21/17
	LVE 250		V = 1/16" x 90°	N = 21	TD046	812046	175 - 250	3 - 25	330	TT34
	ZG / ZS 250		S = 12,72	N = 19,03	TZ040	814040	150 - 250	3 - 25	330	
	DURO-NCSE 265		265	S = 12	N = 20	TK040	811040	150 - 261	3 - 25	345
	DURO 315	315	S = 12	N = 26	TK050	811050	152 - 318	3 - 25	400	
	DURO-NC 315		S = 12	N = 26	TK050	811050	154 - 320	3 - 25	400	
	DURO-NCES 315		S = 12	N = 20	TK040	811040	150 - 315	3 - 25	395	
	DURO-NCSE 315		S = 12	N = 26	TK050	811050	150 - 315	3 - 25	395	
	DURO-T 315		S = 12	N = 26	TK050	811050	150 - 322	3 - 25	405	
	KFD 315		V = 1/16" x 90°	N = 21	TD046	812046	175 - 290	3 - 25	370	TT34
	KFD-HE 315		V = 1,5mm x 60°	N = 21	TM052	813052	220 - 315	3 - 25	395	X6115
	KFD-HE 315		V = 1/16" x 90°	N = 21	TD046	812046	210 - 315	3 - 25	395	TT34
	KFD-HS 315		V = 1/16" x 90°	N = 21	TD046	812046	175 - 315	3 - 25	395	TT34
	LVE 315		V = 1/16" x 90°	N = 21	TD046	812046	190 - 315	3 - 25	395	TT34
	ZG / ZS 315	S = 12,72	N = 19,03	TZ043	814043	185 - 315	3 - 25	395		
	ZG / ZS 350	350	S = 12,72	N = 19,03	TZ060	814060	250 - 350	6 - 50	460	
	DURO 400	400	S = 18	N = 30	TK080	811080	250 - 400	6 - 50	510	
	DURO-NC 400		S = 18	N = 30	TK080	811080	250 - 400	6 - 50	510	
	DURO-NCES 400		S = 12	N = 26	TK060	811060	250 - 375	6 - 50	485	
	DURO-T 400		S = 18	N = 30	TK080	811080	250 - 407	6 - 50	515	
	KFD 400		V = 3/32" x 90°	N = 25,5	TD066	812066	265 - 400	6 - 50	510	GE40
	KFD-HE 400		V = 3/32" x 90°	N = 25,5	TD066	812066	285 - 400	6 - 50	510	GE40
	KFD-HS 400		V = 3/32" x 90°	N = 25,5	TD066	812066	280 - 400	6 - 50	510	GE40
	LVE 420		V = 3/32" x 90°	N = 25,5	TD066	812066	315 - 400	6 - 50	510	GE40
	LVE 480		V = 3/32" x 90°	N = 25,5	TD066	812066	365 - 400	6 - 50	510	GE40
	ZG / ZS 350		S = 12,72	N = 19,03	TZ060	814060	250 - 400	6 - 50	510	
	ZG / ZS 350	S = 12,72	N = 19,03	TZ060	814060	250 - 400	6 - 50	510		
	ZG / ZS 400	S = 12,72	N = 19,03	TZ060	814060	250 - 350	6 - 50	460		
	ZG / ZS 400	S = 12,72	N = 19,03	TZ060	814060	250 - 400	6 - 50	510		
	DURO 500	500	S = 18	N = 30	TK080	811080	250 - 500	6 - 50	610	
DURO-NC 500	S = 18		N = 30	TK080	811080	250 - 500	6 - 50	610		
DURO-T 500	S = 18		N = 30	TK080	811080	250 - 507	6 - 50	615		
ZG / ZS 500	S = 12,72		N = 19,03	TZ063	814063	250 - 500	6 - 50	610		
DURO-NCSE 630	630	S = 18	N = 30	TK080	811080	250 - 583	6 - 50	690		



INOTop®

Futterspezifische Daten Chuck specific data

Technische Daten siehe Seite 124-125

Technical data see page 124-125

Futterhersteller chuck manufacturer	Futtertyp chuck type	Futter- größe chuck size	Backenanschluss des Futters jaw-connection of the chuck		Typbe- zeichnung type de- signation	Ident-Nr. ident-no.	Spannbereich [aussein] clamping range [external]	Bauteilwand- stärke wall thickness of workpiece	Schwing- kreis swing	* Benötigter Nutenstein * needed t-nut
			ø mm	S mm / V						
Samchully	HC-08	210	V = 1,5mm x 60°	N = 14	TM030	813030	155 - 210	3 - 25	290	GP08
	HCH-08		V = 1,5mm x 60°	N = 14	TM030	813030	150 - 210	3 - 25	290	GP08
	HH-208 / MH-208		V = 1,5mm x 60°	N = 14	TM030	813030	155 - 210	3 - 25	290	GP09
	HS-08		V = 1,5mm x 60°	N = 14	TM030	813030	150 - 210	3 - 25	290	GP09
	HC-10	254	V = 1,5mm x 60°	N = 16	TM040	813040	165 - 254	3 - 25	335	TT22
	HCH-10		V = 1,5mm x 60°	N = 16	TM040	813040	165 - 254	3 - 25	335	TT22
	HH-210 / MH-210		V = 1,5mm x 60°	N = 16	TM040	813040	195 - 254	3 - 25	335	TT70
	HS-10		V = 1,5mm x 60°	N = 16	TM040	813040	160 - 254	3 - 25	335	TT70
	HC-12	304	V = 1,5mm x 60°	N = 18	TM050	813050	185 - 304	3 - 25	385	GN78
	HCH-12		V = 1,5mm x 60°	N = 18	TM050	813050	180 - 304	3 - 25	385	GN78
	HS-12		V = 1,5mm x 60°	N = 21	TM052	813052	185 - 304	3 - 25	385	TT40
	HH-212 / MH-212	315	V = 1,5mm x 60°	N = 21	TM052	813052	205 - 315	3 - 25	395	TT40
	HC-15	381	V = 1,5mm x 60°	N = 25,5	TM060	813060	275 - 381	6 - 50	490	X5507
	HCH-15 / HCH-18		V = 1,5mm x 60°	N = 22	TM060	813060	275 - 381	6 - 50	490	GP15
Schunk	ROTA G 200	200	S = 10	N = 20	TK030	811030	153 - 206	3 - 25	290	
	ROTA S plus 200		S = 10	N = 20	TK030	811030	150 - 206	3 - 25	290	
	ROTA NC 210	210	V = 1,5mm x 60°	N = 14	TM030	813030	150 - 210	3 - 25	290	GP08
	ROTA NC 210		V = 1/16" x 90°	N = 17	TD040	812040	150 - 210	3 - 25	290	GF212
	ROTA NCF 210		V = 1,5mm x 60°	N = 14	TM030	813030	150 - 210	3 - 25	290	GP08
	ROTA NCF 210		V = 1/16" x 90°	N = 17	TD040	812040	150 - 210	3 - 25	290	GF212
	ROTA NCK 210	210	V = 1,5mm x 60°	N = 14	TM030	813030	150 - 210	3 - 25	290	GP09
	ROTA NCK plus 210		V = 1,5mm x 60°	N = 14	TM030	813030	150 - 210	3 - 25	290	GP09
	ROTA NCK plus 210		V = 1/16" x 90°	N = 17	TD040	812040	150 - 210	3 - 25	290	GF212
	ROTA NCO 210		V = 1/16" x 90°	N = 17	TD040	812040	150 - 210	3 - 25	290	GF212
	ROTA THW 210		S = 10	N = 20	TK030	811030	150 - 210	3 - 25	290	

Futterhersteller chuck manufacturer	Futtertyp chuck type	Futter- größe chuck size	Backenanschluss des Futters jaw-connection of the chuck		Type- zeichnung type de- signation	Ident-Nr. ident-no.	Spannbereich [ausßen] clamping range [external] min.-max./mm	Bauteilwand- stärke wall thickness of workpiece min.-max./mm	Schwing- kreis swing Ø mm	* Benötigter Nutenstein * needed t-nut	
			o mm	S mm / V							N mm
Schunk	ROTA NC plus 215	215	V = 1/16" x 90°	N = 17	TD040	812040	160 - 215	3 - 25	295	GF212	
	ROTA NC plus 215		V = 1,5mm x 60°	N = 14	TM030	813030	165 - 215	3 - 25	295	GP09	
	ROTA NCD 215		V = 1/16" x 90°	N = 17	TD040	812040	150 - 215	3 - 25	295	GG20	
	ROTA NCD 215		V = 1,5mm x 60°	N = 14	TM030	813030	150 - 215	3 - 25	295	GP09	
	ROTA NCF plus 215		V = 1/16" x 90°	N = 17	TD040	812040	160 - 215	3 - 25	295	GF212	
	ROTA NCF plus 215		V = 1,5mm x 60°	N = 14	TM030	813030	165 - 215	3 - 25	295	GP09	
	ROTA THW plus 215		S = 10	N = 20	TK030	811030	150 - 215	3 - 25	295		
	ROTA NCW 225	225	S = 10	N = 20	TK030	811030	150 - 225	3 - 25	305		
	ROTA G 250	250	S = 12	N = 20	TK040	811040	150 - 256	3 - 25	340		
	ROTA NC 250		V = 1,5mm x 60°	N = 16	TM040	813040	170 - 254	3 - 25	335	TT22	
	ROTA NC 250		V = 1/16" x 90°	N = 21	TD046	812046	165 - 254	3 - 25	335	TT46	
	ROTA NCD 250		V = 1,5mm x 60°	N = 21	TM040	813040	165 - 250	3 - 25	330	TT22	
	ROTA NCD 250		V = 1/16" x 90°	N = 21	TD046	812046	155 - 250	3 - 25	330	TT35	
	ROTA NCF 250		V = 1,5mm x 60°	N = 16	TM040	813040	170 - 254	3 - 25	335	TT22	
	ROTA NCF 250		V = 1/16" x 90°	N = 21	TD046	812046	165 - 254	3 - 25	335	TT46	
	ROTA NCK 250		V = 1,5mm x 60°	N = 16	TM040	813040	150 - 254	3 - 25	335	TT70	
	ROTA NCK plus 250		V = 1/16" x 90°	N = 17	TD040	812040	160 - 254	3 - 25	335	GF212	
	ROTA NCK plus 250		V = 1,5mm x 60°	N = 16	TM040	813040	165 - 254	3 - 25	335	TT70	
	ROTA S plus 250		S = 12	N = 20	TK040	811040	150 - 256	3 - 25	340		
	ROTA THW 250		S = 12	N = 20	TK040	811040	150 - 250	3 - 25	330		
	ROTA NCD 255		255	V = 1,5mm x 60°	N = 21	TM040	813040	160 - 255	3 - 25	335	TT70
	ROTA NCD 255			V = 1/16" x 90°	N = 21	TD046	812046	155 - 255	3 - 25	335	TT35
	ROTA NC plus 260		260	V = 1,5mm x 60°	N = 16	TM040	813040	180 - 260	3 - 25	340	TT70
	ROTA NC plus 260			V = 1/16" x 90°	N = 21	TD046	812046	180 - 254	3 - 25	335	TT46
	ROTA NCF plus 260			V = 1,5mm x 60°	N = 16	TM040	813040	180 - 260	3 - 25	340	TT70
	ROTA NCF plus 260			V = 1/16" x 90°	N = 21	TD046	812046	170 - 260	3 - 25	340	TT46
	ROTA NCO 260			V = 1/16" x 90°	N = 21	TD046	812046	175 - 254	3 - 25	335	TT46
	ROTA THW plus 260	S = 12		N = 20	TK040	811040	150 - 260	3 - 25	340		
	ROTA NCW 265	265		S = 12	N = 20	TK040	811040	150 - 256	3 - 25	340	
	ROTA G 315	315	S = 12	N = 20	TK040	811040	150 - 322	3 - 25	405		
	ROTA NC 315-86		V = 1,5mm x 60°	N = 18	TM050	813050	200 - 315	3 - 25	395	GN78	
	ROTA NC 315-86		V = 1/16" x 90°	N = 21	TD046	812046	195 - 315	3 - 25	395	TT35	
ROTA NC plus 315	V = 1,5mm x 60°		N = 21	TM052	813052	195 - 315	3 - 25	395	GF34		
ROTA NC plus 315	V = 1/16" x 90°		N = 21	TD046	812046	195 - 315	3 - 25	395	TT46		



INOTop®

Futterspezifische Daten Chuck specific data

Technische Daten siehe Seite 124-125

Technical data see page 124-125

Futterhersteller chuck manufacturer	Futtertyp chuck type	Futter- größe chuck size	Backenanschluss des Futters jaw-connection of the chuck		Typbe- zeichnung type de- signation	Ident-Nr. ident-no.	Spannbereich [ausßen] clamping range [external]	Bauteilwand- stärke wall thickness of workpiece	Schwing- kreis swing	* Benötigter Nutenstein * needed t-nut
			ø mm	S mm / V						
Schunk	ROTA NCD 315	315	V = 1/16" x 90°	N = 21	TD046	812046	180 – 315	3 – 25	395	TT35
	ROTA NCD 315		V = 1,5mm x 60°	N = 21	TM052	813052	195 – 315	3 – 25	395	TT35
	ROTA NCF 315		V = 1,5mm x 60°	N = 18	TM050	813050	195 – 315	3 – 25	395	GN78
	ROTA NCF 315		V = 1/16" x 90°	N = 21	TD046	812046	190 – 315	3 – 25	395	TT35
	ROTA NCF plus 315		V = 1,5mm x 60°	N = 21	TM052	813052	195 – 315	3 – 25	395	TT40
	ROTA NCF plus 315		V = 1/16" x 90°	N = 21	TD046	812046	195 – 315	3 – 25	395	TT46
	ROTA NCK plus 315		V = 1,5mm x 60°	N = 21	TM052	813052	190 – 304	3 – 25	385	TT40
	ROTA NCK plus 315		V = 1/16" x 90°	N = 21	TD046	812046	185 – 304	3 – 25	385	TT46
	ROTA NCO 315		V = 1/16" x 90°	N = 21	TD046	812046	185 – 315	3 – 25	395	TT46
	ROTA NCW 315		S = 12	N = 20	TK040	811040	150 – 303	3 – 25	385	
	ROTA S plus 315		S = 12	N = 26	TK050	811050	150 – 323	3 – 25	405	
	ROTA THW 315		S = 12	N = 20	TK040	811040	150 – 303	3 – 25	385	
	ROTA THW plus 315		S = 12	N = 20	TK040	811040	150 – 315	3 – 25	395	
	ROTA G 400	400	S = 12	N = 26	TK060	811060	250 – 394	6 – 50	500	
	ROTA NC 400		V = 1,5mm x 60°	N = 22	TM060	813060	265 – 400	6 – 50	510	GP15
	ROTA NC 400		V = 3/32" x 90°	N = 25,5	TD066	812066	285 – 400	6 – 50	510	GN40
	ROTA NCD 400		V = 3/32" x 90°	N = 25,5	TD066	812066	270 – 400	6 – 50	510	GN40
	ROTA NCF 400		V = 1,5mm x 60°	N = 22	TM060	813060	265 – 400	6 – 50	510	GP15
	ROTA NCF 400		V = 3/32" x 90°	N = 25,5	TD066	812066	285 – 390	6 – 50	500	GN40
	ROTA NCO 400		V = 3/32" x 90°	N = 25,5	TD066	812066	260 – 400	6 – 50	510	GE40
	ROTA S plus 400		S = 18	N = 30	TK080	811080	250 – 408	6 – 50	515	
	ROTA THW 400		S = 12	N = 26	TK060	811060	250 – 376	6 – 50	485	
	ROTA THW plus 400		S = 12	N = 26	TK060	811060	250 – 376	6 – 50	485	
ROTA G 500	500	S = 18	N = 30	TK080	811080	250 – 507	6 – 50	615		
ROTA S plus 500		S = 18	N = 30	TK080	811080	250 – 507	6 – 50	615		
ROTA THW plus 500		S = 18	N = 30	TK080	811080	250 – 463	6 – 50	570		

Futterhersteller chuck manufacturer	Futtertyp chuck type	Futter- größe chuck size	Backenanschluss des Futters jaw-connection of the chuck		Type- zeichnung type de- signation	Ident-Nr. ident-no.	Spannbereich [ausen] clamping range [external] min.-max./mm	Bauteilwand- stärke wall thickness of workpiece min.-max./mm	Schwing- kreis swing Ø mm	* Benötigter Nutenstein * needed t-nut	
			S mm / V	N mm							
Schunk	ROTA G 630	630	S = 18	N = 30	TK080	811080	250 - 639	6 - 50	745		
	ROTA THW 630		S = 18	N = 30	TK080	811080	250 - 586	6 - 50	695		
	ROTA THW plus 630		S = 18	N = 30	TK080	811080	250 - 583	6 - 50	690		
	ROTA NCO 800	800	V = 3/32" x 90°	N = 25,5	TD066	812066	365 - 800	6 - 50	910	GN40	
SMW Autoblok	HFK / HFKS 200-48	200	V = 1/16" x 90°	N = 17	TD040	812040	150 - 200	3 - 25	280	GG20	
	HFK / HFKS 200-66		V = 1/16" x 90°	N = 17	TD040	812040	150 - 200	3 - 25	280	GG20	
	AL-D 210	210	V = 1/16" x 90°	N = 17	TD040	812040	150 - 210	3 - 25	290	GF212	
	AL-M 210		V = 1,5mm x 60°	N = 14	TM030	813030	155 - 210	3 - 25	290	GF213	
	AN-D 210		V = 1/16" x 90°	N = 17	TD040	812040	150 - 210	3 - 25	290	GF212	
	AN-M 210		V = 1,5mm x 60°	N = 14	TM030	813030	150 - 210	3 - 25	290	GF213	
	BB-D 210		V = 1/16" x 90°	N = 17	TD040	812040	150 - 210	3 - 25	290	GF212	
	BB-M 210		V = 1,5mm x 60°	N = 14	TM030	813030	155 - 210	3 - 25	290	GF213	
	BH-D 210		V = 1/16" x 90°	N = 17	TD040	812040	150 - 210	3 - 25	290	GF212	
	BHD-FC 210		V = 1/16" x 90°	N = 17	TD040	812040	150 - 210	3 - 25	290	GF212	
	BH-M 210		V = 1,5mm x 60°	N = 14	TM030	813030	150 - 210	3 - 25	290	GF213	
	BHM-FC 210		V = 1,5mm x 60°	N = 14	TM030	813030	150 - 210	3 - 25	290	GF213	
	HFKN-D 210		V = 1/16" x 90°	N = 17	TD040	812040	150 - 210	3 - 25	290	GF212	
	HFKN-M 210		V = 1,5mm x 60°	N = 14	TM030	813030	150 - 210	3 - 25	290	GF213	
	HG-F 210		S = 10	N = 20	TK030	811030	150 - 198	3 - 25	280		
	HG-N 210		S = 10	N = 20	TK030	811030	150 - 201	3 - 25	285		
	KNCS-N 210		S = 10	N = 20	TK030	811030	150 - 215	3 - 25	295		
	KNCS-N 225		225	S = 10	N = 20	TK030	811030	150 - 225	3 - 25	310	
	AL-D 250		250	V = 1/16" x 90°	N = 21	TD046	812046	170 - 254	3 - 25	335	TT46
	AL-M 250			V = 1,5mm x 60°	N = 16	TM040	813040	175 - 254	3 - 25	335	TT24
	AN-D 250	V = 1/16" x 90°		N = 21	TD046	812046	165 - 254	3 - 25	335	TT46	
	AN-M 250	V = 1,5mm x 60°		N = 16	TM040	813040	170 - 254	3 - 25	335	TT24	
	BB-D 250	V = 1/16" x 90°		N = 21	TD046	812046	175 - 254	3 - 25	335	TT46	
	BB-M 250	V = 1,5mm x 60°		N = 16	TM040	813040	180 - 254	3 - 25	335	TT24	
	BH-D 250	V = 1/16" x 90°		N = 21	TD046	812046	165 - 254	3 - 25	335	TT46	
	BHD-FC 250	V = 1/16" x 90°		N = 21	TD046	812046	165 - 250	3 - 25	330	TT46	
BH-M 250	V = 1,5mm x 60°	N = 16		TM040	813040	170 - 254	3 - 25	335	TT24		
BHM-FC 250	V = 1,5mm x 60°	N = 16		TM040	813040	170 - 250	3 - 25	330	TT24		
HFK / HFKS 250	V = 1/16" x 90°	N = 21		TD046	812046	165 - 250	3 - 25	330	TT35		



INOTop®

Futterspezifische Daten Chuck specific data

Technische Daten siehe Seite 124-125

Technical data see page 124-125

Futterhersteller chuck manufacturer	Futtertyp chuck type	Futter- größe chuck size ø mm	Backenanschluss des Futters jaw-connection of the chuck		Typbe- zeichnung type de- signation	Ident-Nr. ident-no.	Spannbereich [ausßen] clamping range [external] min.-max./mm	Bauteilwand- stärke wall thickness of workpiece min.-max./mm	Schwing- kreis swing Ø mm	* Benötigter Nutenstein * needed t-nut
			S mm / V	N mm						
SMW Autoblok	HFKN-D 260	260	V = 1/16" x 90°	N = 21	TD046	812046	165 - 254	3 - 25	335	TT46
	HFKN-M 260		V = 1,5mm x 60°	N = 21	TM040	813040	170 - 260	3 - 25	340	*
	HG-F 260		S = 12	N = 20	TK040	811040	150 - 249	3 - 25	330	
	HG-N 260		S = 12	N = 20	TK040	811040	150 - 249	3 - 25	330	
	KNCS-N 260		S = 12	N = 20	TK040	811040	150 - 258	3 - 25	340	
	HFK / HFKS 270	270	V = 1/16" x 90°	N = 21	TD046	812046	175 - 270	3 - 25	350	TT35
	KNCS-N 275	275	S = 12	N = 20	TK040	811040	150 - 273	3 - 25	355	
	AL-D 315	315	V = 1/16" x 90°	N = 21	TD046	812046	185 - 315	3 - 25	395	TT46
	AL-M 315		V = 1,5mm x 60°	N = 21	TM052	813052	190 - 315	3 - 25	395	GF34
	AN-D 315		V = 1/16" x 90°	N = 21	TD046	812046	180 - 315	3 - 25	395	TT46
	AN-M 315		V = 1,5mm x 60°	N = 21	TM052	813052	185 - 315	3 - 25	395	GF34
	BB-D 315		V = 1/16" x 90°	N = 21	TD046	812046	225 - 315	3 - 25	395	TT46
	BB-M 315	V = 1,5mm x 60°	N = 21	TM052	813052	230 - 315	3 - 25	395	GF34	
	BHD-FC 315	V = 1/16" x 90°	N = 21	TD046	812046	195 - 315	3 - 25	395	TT46	
	BH-M 315	V = 1,5mm x 60°	N = 21	TM052	813052	200 - 315	3 - 25	395	GF34	

* Sondernutenstein
* special t-nut

Futterhersteller chuck manufacturer	Futtertyp chuck type	Futter- größe chuck size ø mm	Backenanschluss des Futters jaw-connection of the chuck		Typbe- zeichnung type de- signation	Ident-Nr. ident-no.	Spannbereich [aussen] clamping range [external] min.-max./mm	Bauteilwand- stärke wall thickness of workpiece min.-max./mm	Schwing- kreis swing Ø mm	* Benötigter Nutenstein * needed t-nut
			S mm / V	N mm						
SMW Autoblok	BHM-FC 315	315	V = 1,5mm x 60°	N = 21	TM052	813052	200 - 315	3 - 25	395	GF34
	HB-D 315		V = 1/16" x 90°	N = 21	TD046	812046	190 - 315	3 - 25	395	*
	HFK / HFKS 315		V = 1/16" x 90°	N = 21	TD046	812046	185 - 315	3 - 25	395	TT35
	HFKN-D 315		V = 1/16" x 90°	N = 21	TD046	812046	205 - 315	3 - 25	395	TT46
	HFKN-M 315		V = 1,5mm x 60°	N = 21	TM052	813052	210 - 315	3 - 25	395	GF34
	HG-F 315		S = 12	N = 26	TK050	811050	150 - 315	3 - 25	395	
	HG-N 315		S = 12	N = 20	TK040	811040	150 - 305	3 - 25	385	
	KNCS-N 315	S = 12	N = 20	TK040	811040	150 - 315	3 - 25	395		
	KNCS-N 325	325	S = 12	N = 20	TK040	811040	150 - 324	3 - 25	405	
	KNCS-N 340	340	S = 12	N = 20	TK040	811040	165 - 340	3 - 25	420	
	KNCS-N 340		S = 12	N = 20	TK040	811040	165 - 340	3 - 25	420	
	AN-D 400	400	V = 3/32" x 90°	N = 25,5	TD066	812066	285 - 390	6 - 50	500	GE40
	AN-M 400		V = 1,5mm x 60°	N = 22	TM060	813060	285 - 390	6 - 50	500	X7960
	BH-D 400		V = 3/32" x 90°	N = 25,5	TD066	812066	285 - 390	6 - 50	500	GE40
	BHD-FC 400		V = 3/32" x 90°	N = 25,5	TD066	812066	285 - 390	6 - 50	500	GE40
	BH-M 400		V = 1,5mm x 60°	N = 22	TM060	813060	285 - 390	6 - 50	500	X7960
	HFK / HFKS 400		V = 3/32" x 90°	N = 25,5	TD066	812066	285 - 400	6 - 50	510	GN40
	HFKN-D 400		V = 3/32" x 90°	N = 25,5	TD066	812066	250 - 400	6 - 50	510	GN40
	HG-F 400	S = 18	N = 30	TK080	811080	250 - 400	6 - 50	510		
	HG-N 400	S = 12	N = 26	TK060	811060	250 - 372	6 - 50	480		
	KNCS-N 400	S = 12	N = 26	TK060	811060	250 - 400	6 - 50	510		
	KNCS-N 400	S = 12	N = 26	TK060	811060	250 - 400	6 - 50	510		
	HG-N 500	500	S = 18	N = 30	TK080	811080	250 - 462	6 - 50	570	
KNCS-N 500	S = 18		N = 30	TK080	811080	250 - 492	6 - 50	600		
HG-N 630	630	S = 18	N = 30	TK080	811080	262 - 622	6 - 50	730		
KNCS-N 630		S = 18	N = 30	TK080	811080	250 - 583	6 - 50	690		

INOTop®

Allgemeine technische Daten General technical data

INOTop®	Ident-Nr. ident-no.	Bauteilwandstärke wall thickness of workpiece W min.-max./mm	Einspanntiefe clamping depth T mm	Breite width B mm	Höhe height H mm	Länge length L mm	max. Anzugs- moment max. tightening torque Nm	max. Spannkraft/ Backe max clamping force/jaw kN	Backenanschluss jaw-connection		Gewicht/ Satz weight/ set kg
									S mm / V	N mm	
TM030	813030	3 - 25	10	47	60	103,5	30	25	V = 1,5mm x 60°	N = 14	4,3
TM040	813040	3 - 25	10	47	60	103,5	30	25	V = 1,5mm x 60°	N = 16	4,3
TM050	813050	3 - 25	10	47	60	103,5	30	25	V = 1,5mm x 60°	N = 18	4,2
TM052	813052	3 - 25	10	47	60	103,5	30	25	V = 1,5mm x 60°	N = 21	4,2
TM060	813060	6 - 50	20	66	84	160	40	30	V = 1,5mm x 60°	N = 22	12
TM062	813062	6 - 50	20	66	84	160	40	30	V = 1,5mm x 60°	N = 21	12
TM080	813080	6 - 50	20	66	84	160	40	30	V = 3,0mm x 60°	N = 25	12
TD040	812040	3 - 25	10	47	60	103	30	25	V = 1/16" x 90°	N = 17	4,3
TD046	812046	3 - 25	10	47	60	103	30	25	V = 1/16" x 90°	N = 21	4,2
TD060	812060	6 - 50	20	66	84	160	40	30	V = 1/16" x 90°	N = 21	12,3
TD063	812063	6 - 50	20	66	84	160	40	30	V = 3/32" x 90°	N = 20	12,3
TD066	812066	6 - 50	20	66	84	160	40	30	V = 3/32" x 90°	N = 25,5	12,4
TK030	811030	3 - 25	10	47	55,5	104	30	25	S = 20	N = 10	4,2
TK040	811040	3 - 25	10	47	55,5	104	30	25	S = 20	N = 12	4,1
TK050	811050	3 - 25	10	47	55,5	104	30	25	S = 26	N = 12	4,1
TK060	811060	6 - 50	20	66	79,5	160	40	30	S = 26	N = 12	12,9
TK080	811080	6 - 50	20	66	79,5	160	40	30	S = 30	N = 18	12,5

Spitzverzahnung
Serration

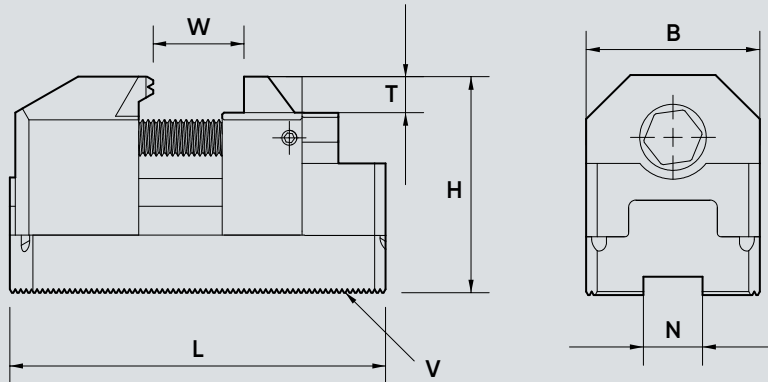

Kreuzversatz
Tongue and groove

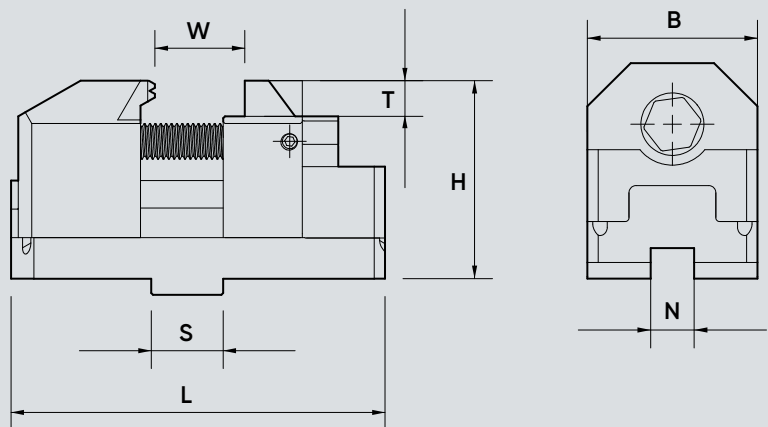

max. Spannkraft/ Backe max clamping force/jaw kN	Backenanschluss jaw-connection		Gewicht/ Satz weight/ set kg
	S mm / V	N mm	
25	S = 12,68	N = 7,94	4,2
25	S = 12,68	N = 7,94	4,2
25	S = 19,03	N = 12,7	4,1
25	S = 19,03	N = 12,7	4,5
30	S = 19,03	N = 12,7	12,7
30	S = 19,03	N = 12,7	12,2

25	V = 2,0mm x 60°	N = 12	4,4
30	V = 3,5mm x 60°	N = 16	13
30	V = 3,5mm x 60°	N = 21	12,8

25	V = 1,5mm x 60°	N = 16	5,7
25	V = 1,5mm x 60°	N = 21	5,6
30	V = 1,5mm x 60°	N = 21	16,1
30	V = 1,5mm x 60°	N = 16	18
30	V = 3,0mm x 60°	N = 25	16

30	V = Modul 2	N = 16	17,6
30	V = Modul 2	N = 21	16,8

25	V = 2,0mm x 60°	N = 12	5,9
30	V = 3,5mm x 60°	N = 16	17,4
30	V = 3,5mm x 60°	N = 21	17,1

INO^{Top}®

Allgemeine technische Daten
General technical data

Spitzverzahnung Serration

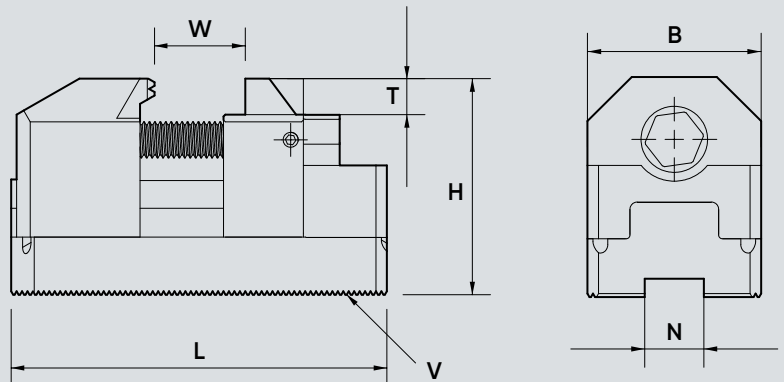

INO ^{Top} ®	Ident-Nr. ident-no.	Bauteilwandstärke	Einspanntiefe
		wall thickness of workpiece	clamping depth
		W	T mm
		min.-max./mm	
TM030	813030	3 - 25	10
TM040	813040	3 - 25	10
TM050	813050	3 - 25	10
TM052	813052	3 - 25	10
TM060	813060	6 - 50	20
TM062	813062	6 - 50	20
TM080	813080	6 - 50	20

TD040	812040	3 - 25	10
TD046	812046	3 - 25	10
TD060	812060	6 - 50	20
TD063	812063	6 - 50	20
TD066	812066	6 - 50	20

TK030	811030	3 - 25	10
TK040	811040	3 - 25	10
TK050	811050	3 - 25	10
TK060	811060	6 - 50	20
TK080	811080	6 - 50	20

Kreuzversatz Tongue and groove

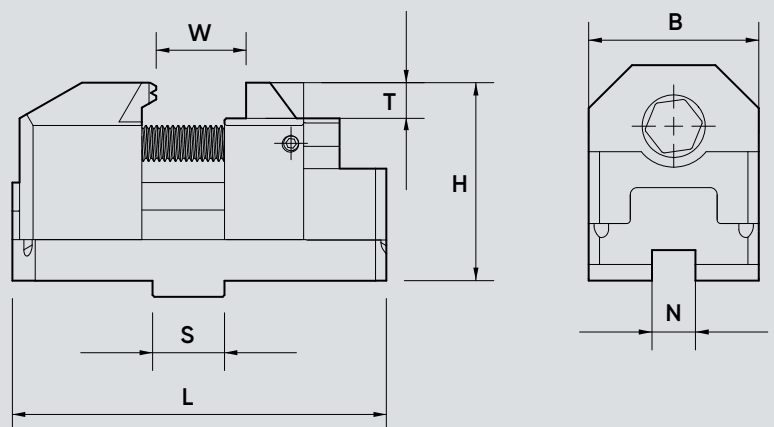

INOTop®	Ident-Nr. ident-no.	Bauteilwandstärke wall thickness of workpiece W min.-max./mm	Einspanntiefe clamping depth T mm	Breite width B mm	Höhe height H mm	Länge length L mm	max. Anzugs- moment max. tightening torque Nm	max. Spannkraft/ Backe max clamping force/jaw kN	Backenanschluss jaw-connection		Gewicht/ Satz weight/ set kg
									S mm / V	N mm	
TZ030	814030	3 - 25	10	47	55,5	104	30	25	S = 12,68	N = 7,94	4,2
TZ031	814031	3 - 25	10	47	55,5	104	30	25	S = 12,68	N = 7,94	4,2
TZ040	814040	3 - 25	10	47	55,5	104	30	25	S = 19,03	N = 12,7	4,1
TZ043	814043	3 - 25	10	47	55,5	122	30	25	S = 19,03	N = 12,7	4,5
TZ060	814060	6 - 50	20	66	79,5	160	40	30	S = 19,03	N = 12,7	12,7
TZ063	814063	6 - 50	20	66	79,5	160	40	30	S = 19,03	N = 12,7	12,2
TW020	815020	3 - 25	10	47	60	160	30	25	V = 2,0mm x 60°	N = 12	4,4
TW030	815030	6 - 50	20	66	84	160	40	30	V = 3,5mm x 60°	N = 16	13
TW040	815040	6 - 50	20	66	84	160	40	30	V = 3,5mm x 60°	N = 21	12,8
TM040-4	813141	3 - 25	10	47	60	103,5	30	25	V = 1,5mm x 60°	N = 16	5,7
TM052-4	813053	3 - 25	10	47	60	103,5	30	25	V = 1,5mm x 60°	N = 21	5,6
TM062-4	813162	6 - 50	20	66	84	160	40	30	V = 1,5mm x 60°	N = 21	16,1
TM066-4	813166	6 - 50	20	66	84	160	40	30	V = 1,5mm x 60°	N = 16	18
TM080-4	813180	6 - 50	20	66	84	160	40	30	V = 3,0mm x 60°	N = 25	16
TR060-4	816160	6 - 50	20	66	84	160	40	30	V = Modul 2	N = 16	17,6
TR080-4	816180	6 - 50	20	66	84	160	40	30	V = Modul 2	N = 21	16,8
TW020-8	815121	3 - 25	10	47	60	160	30	25	V = 2,0mm x 60°	N = 12	5,9
TW030-8	815131	6 - 50	20	66	84	160	40	30	V = 3,5mm x 60°	N = 16	17,4
TW040-8	815141	6 - 50	20	66	84	160	40	30	V = 3,5mm x 60°	N = 21	17,1

